

1

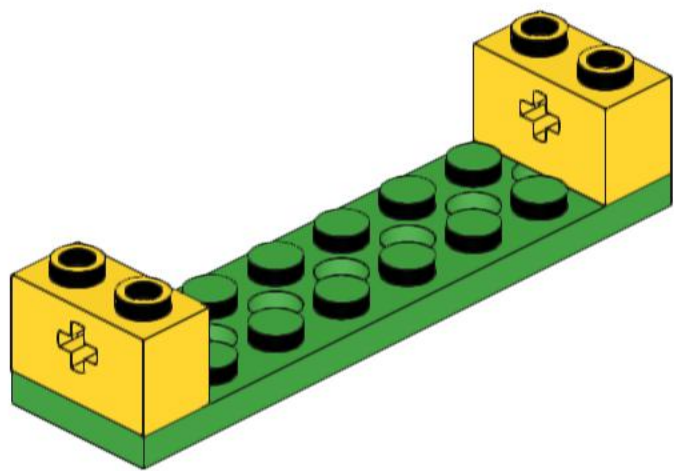

2

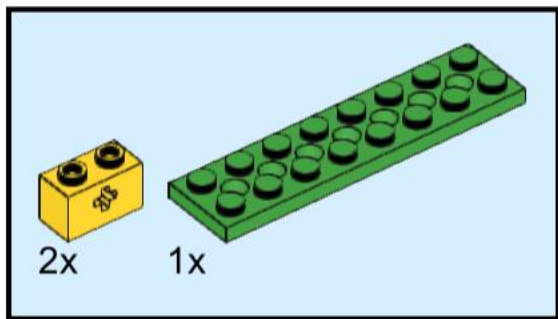
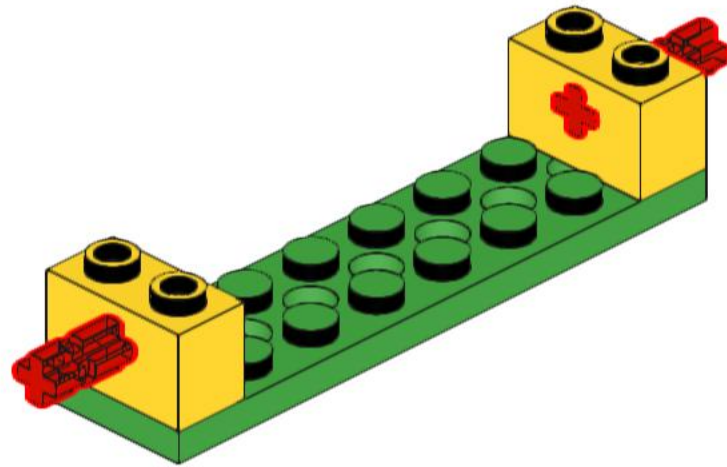
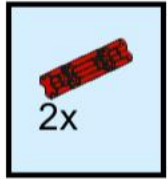

3

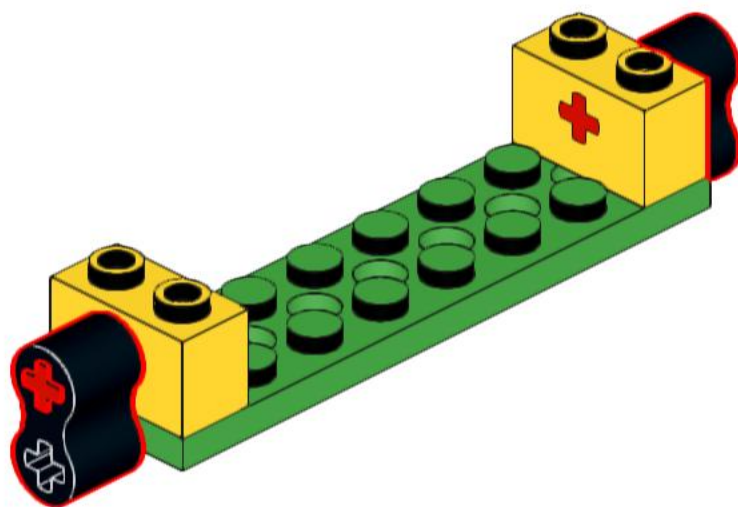

4

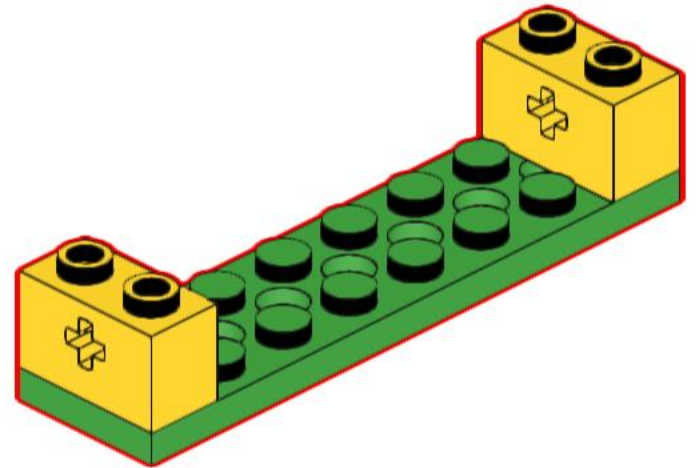
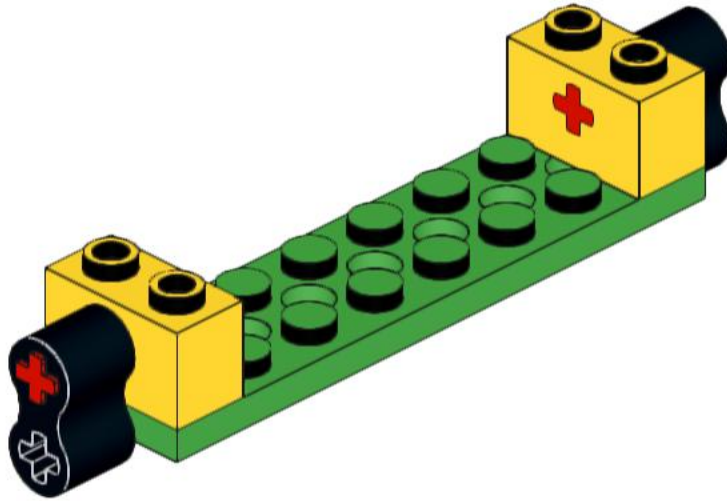
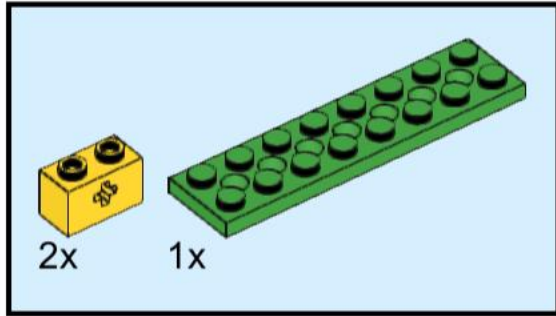

5

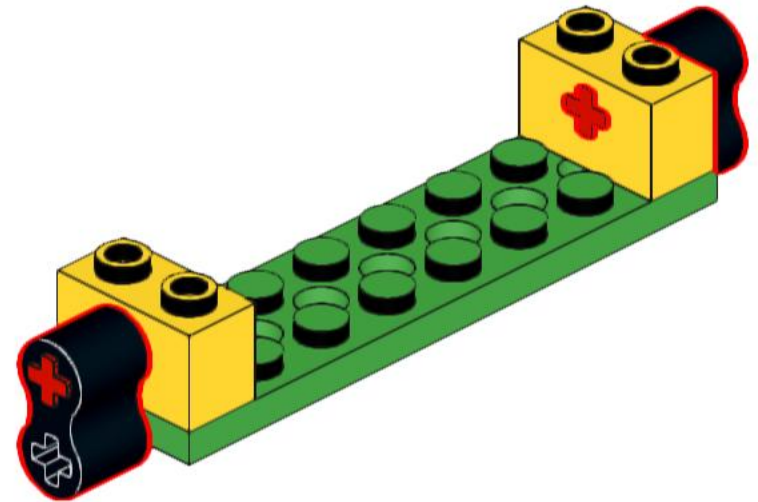
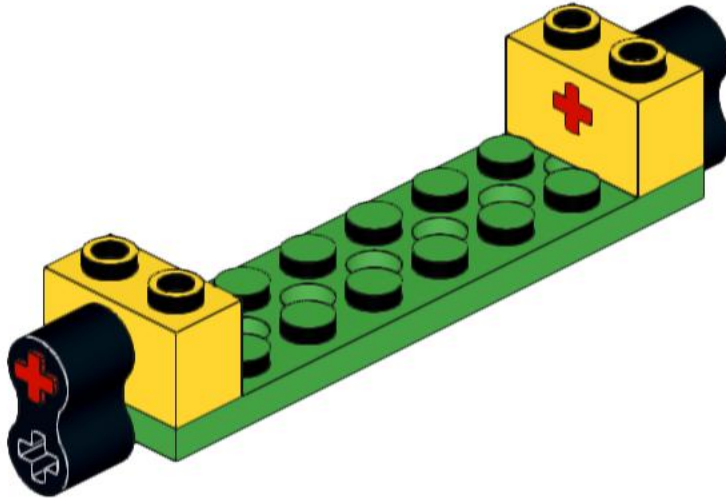
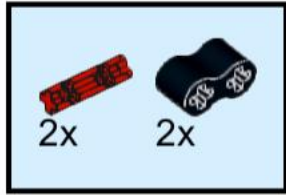

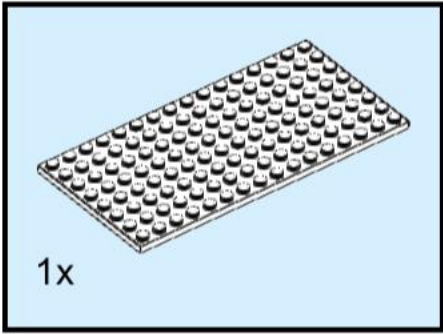

6

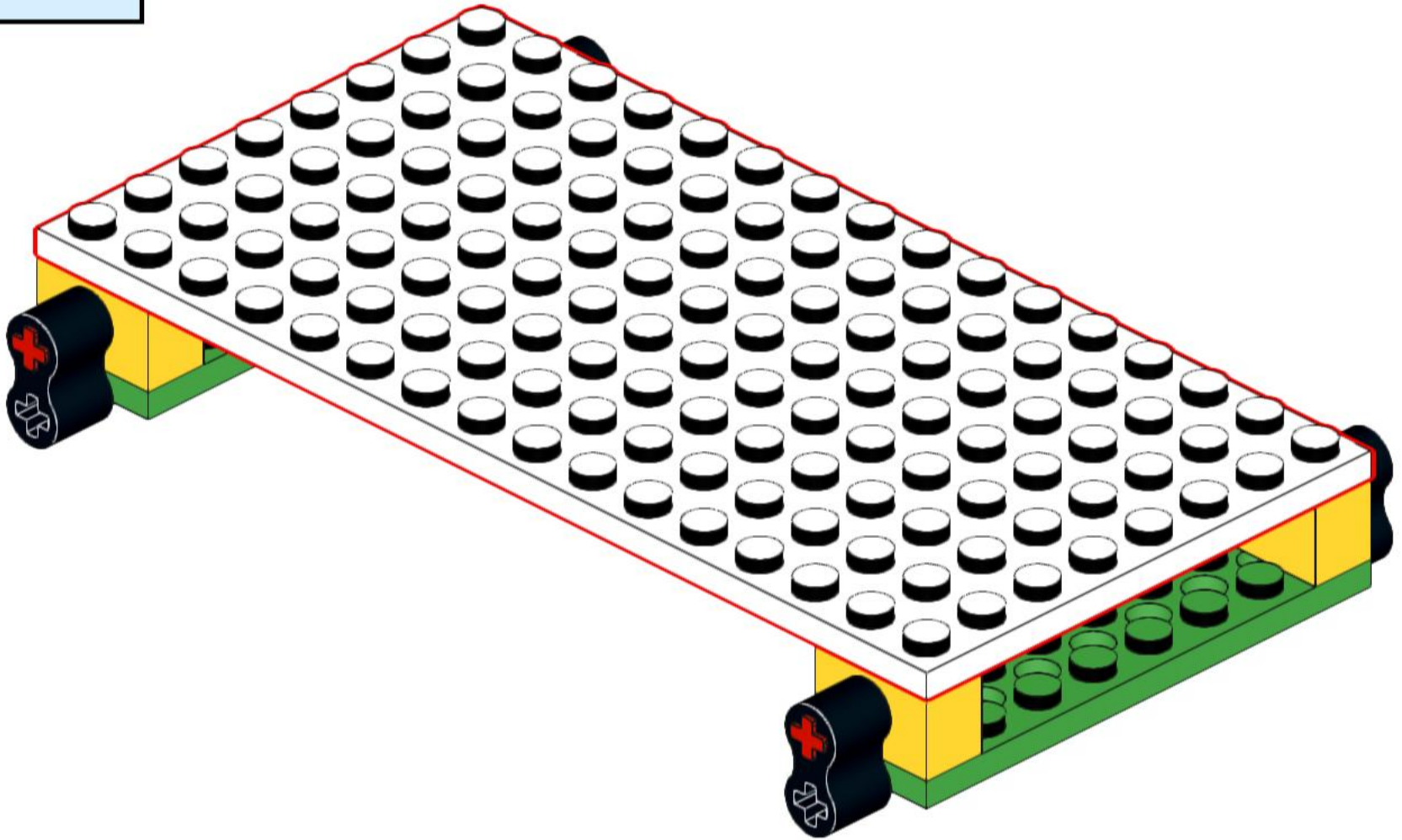

7

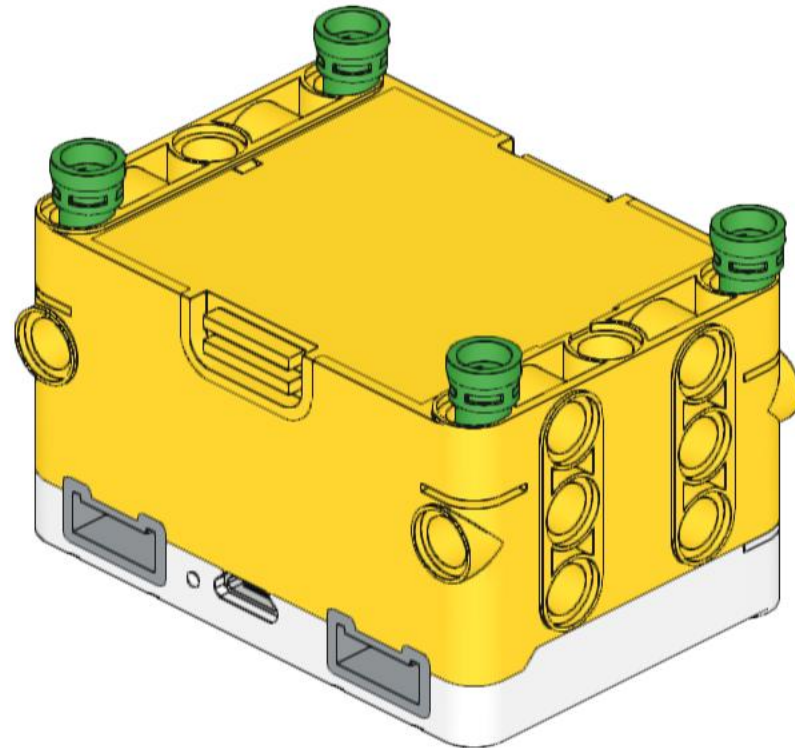
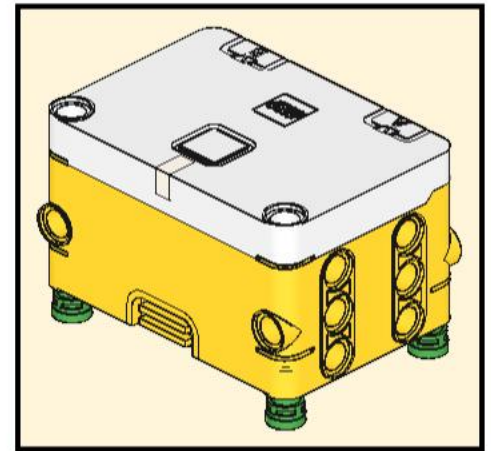
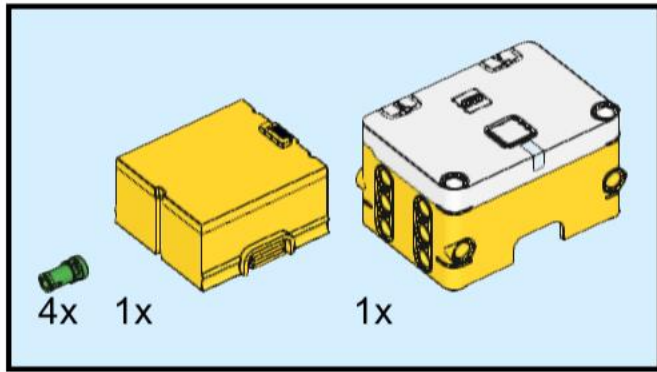



8

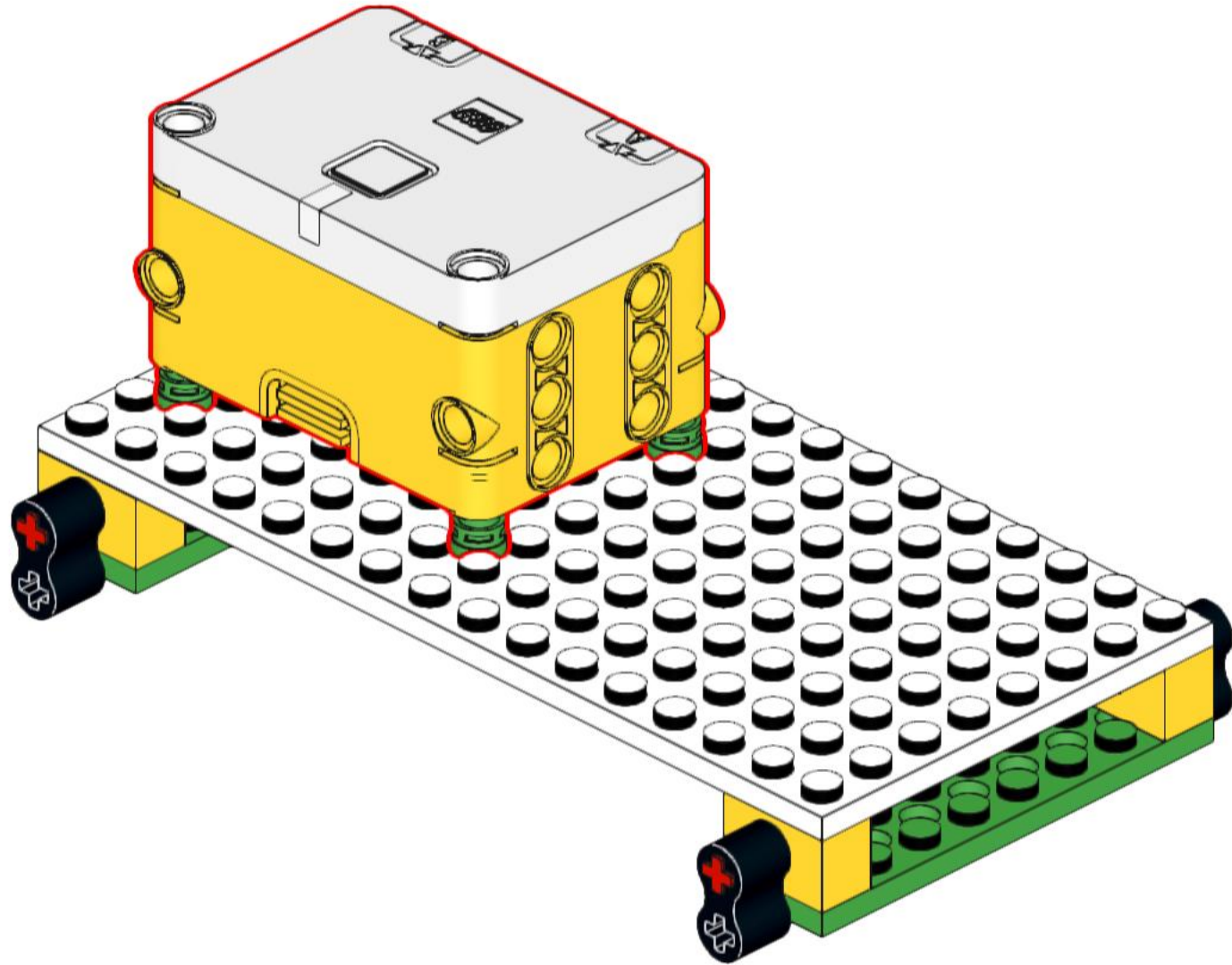



9

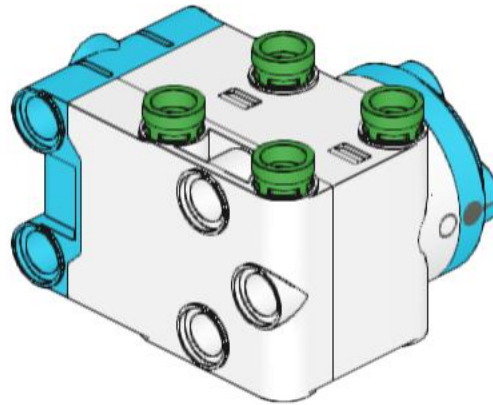
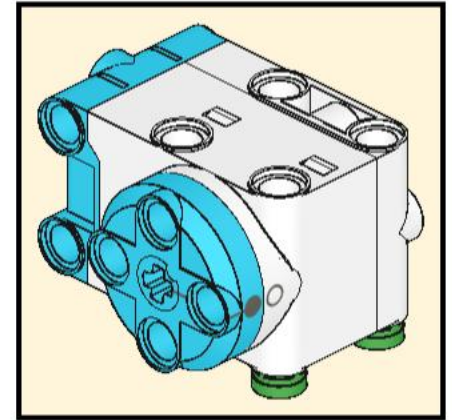
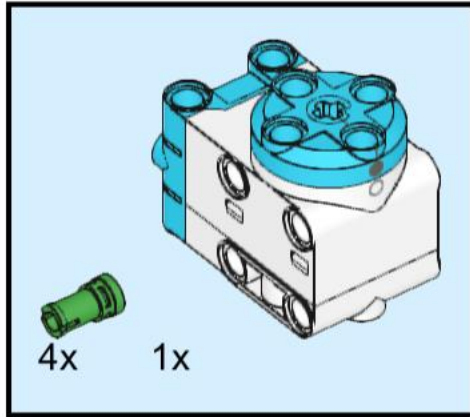

# 10

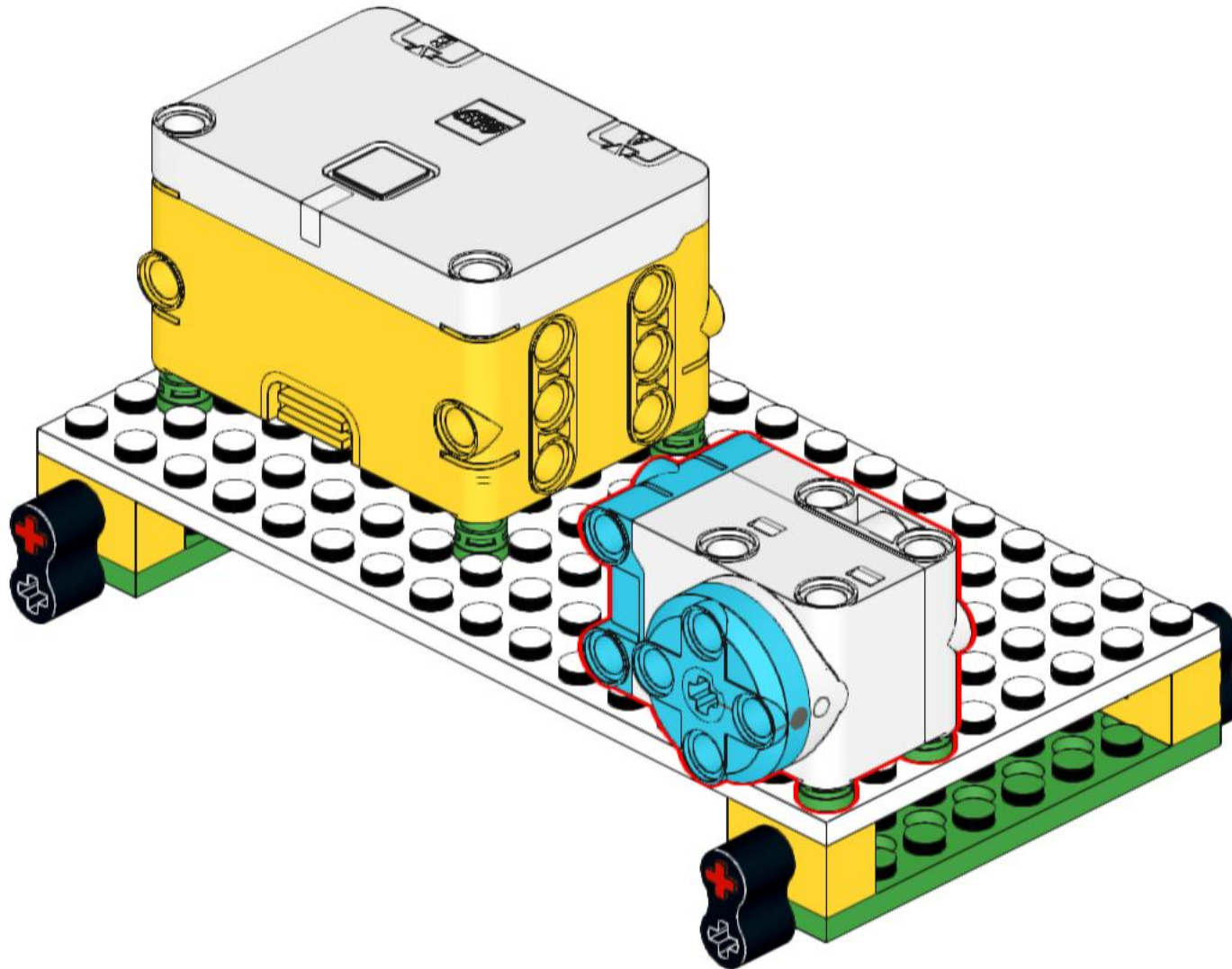

# 11

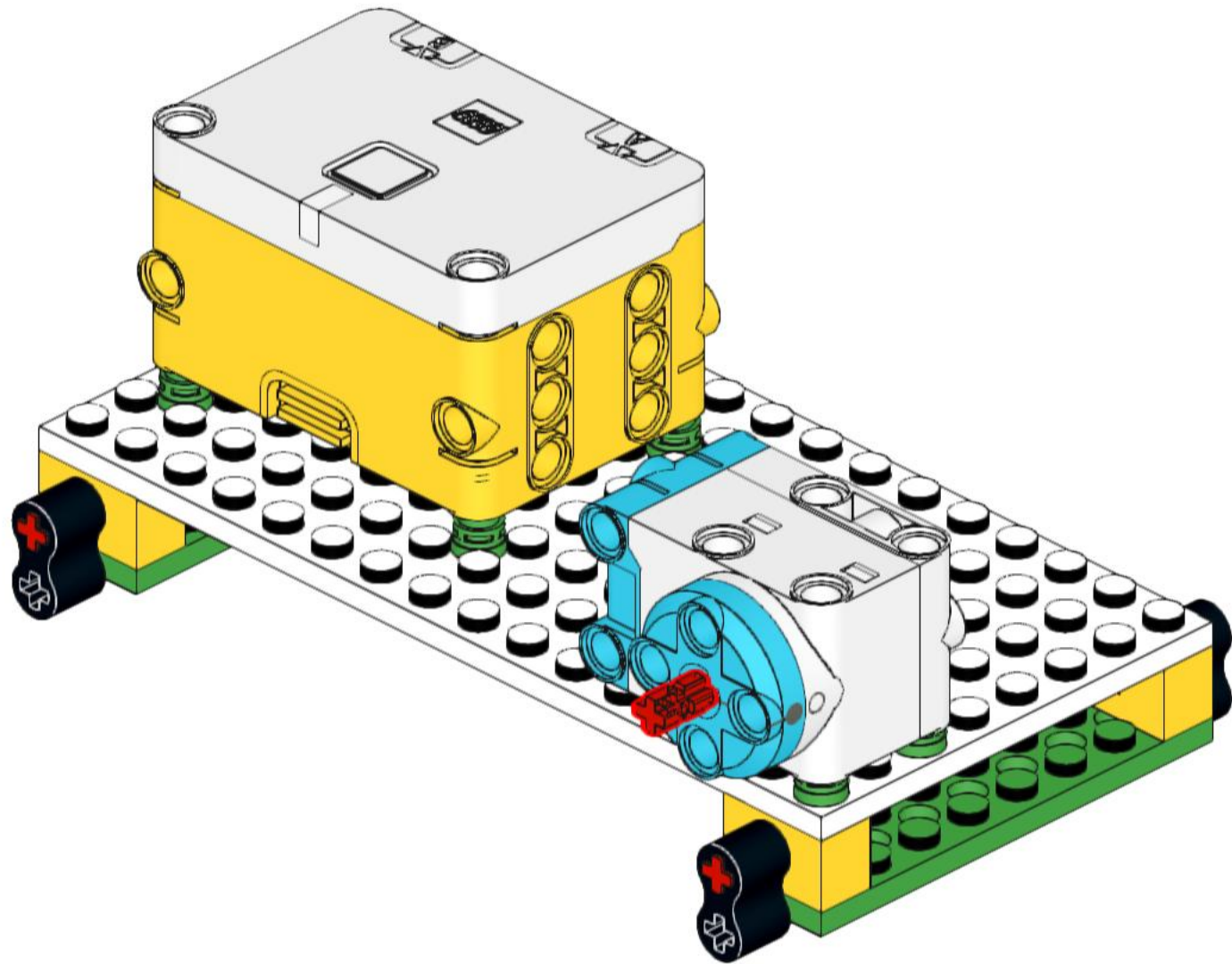
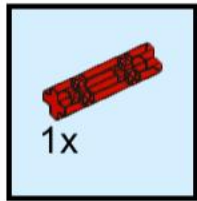

# 12

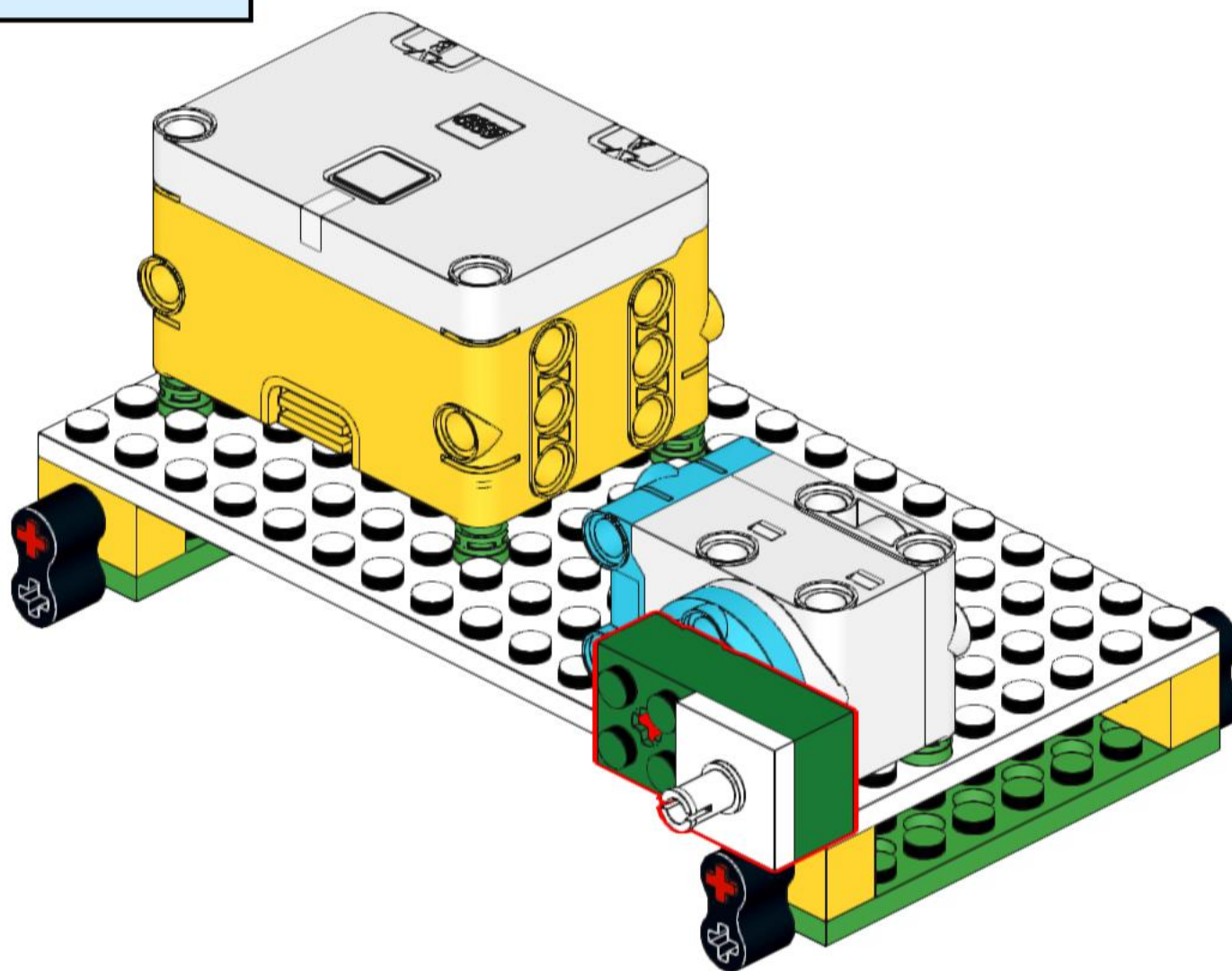
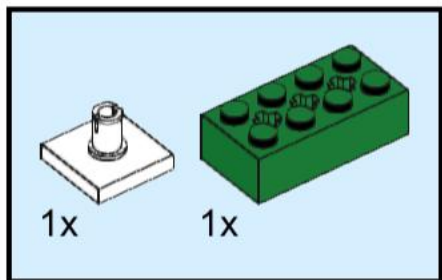

# 13

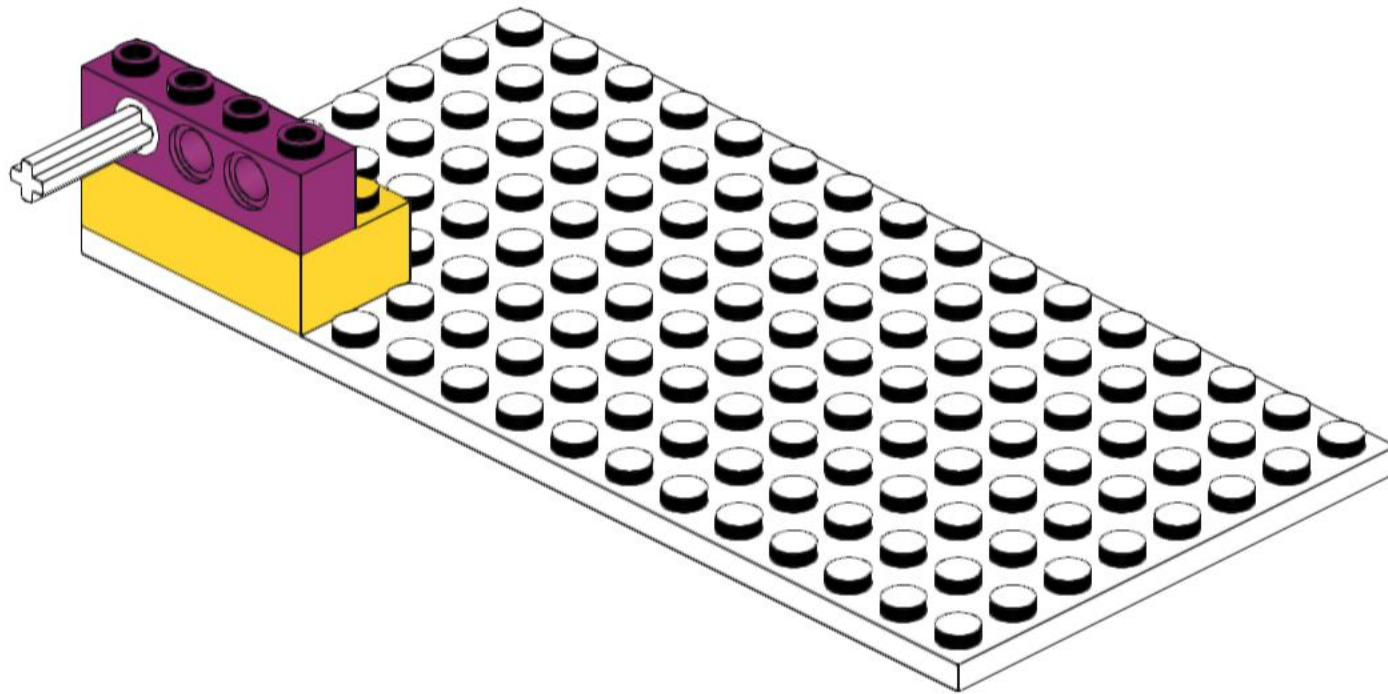
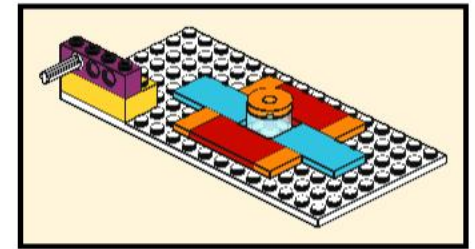
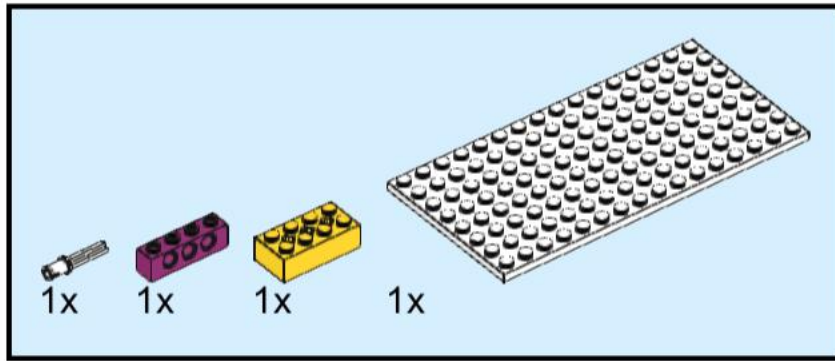



# 14

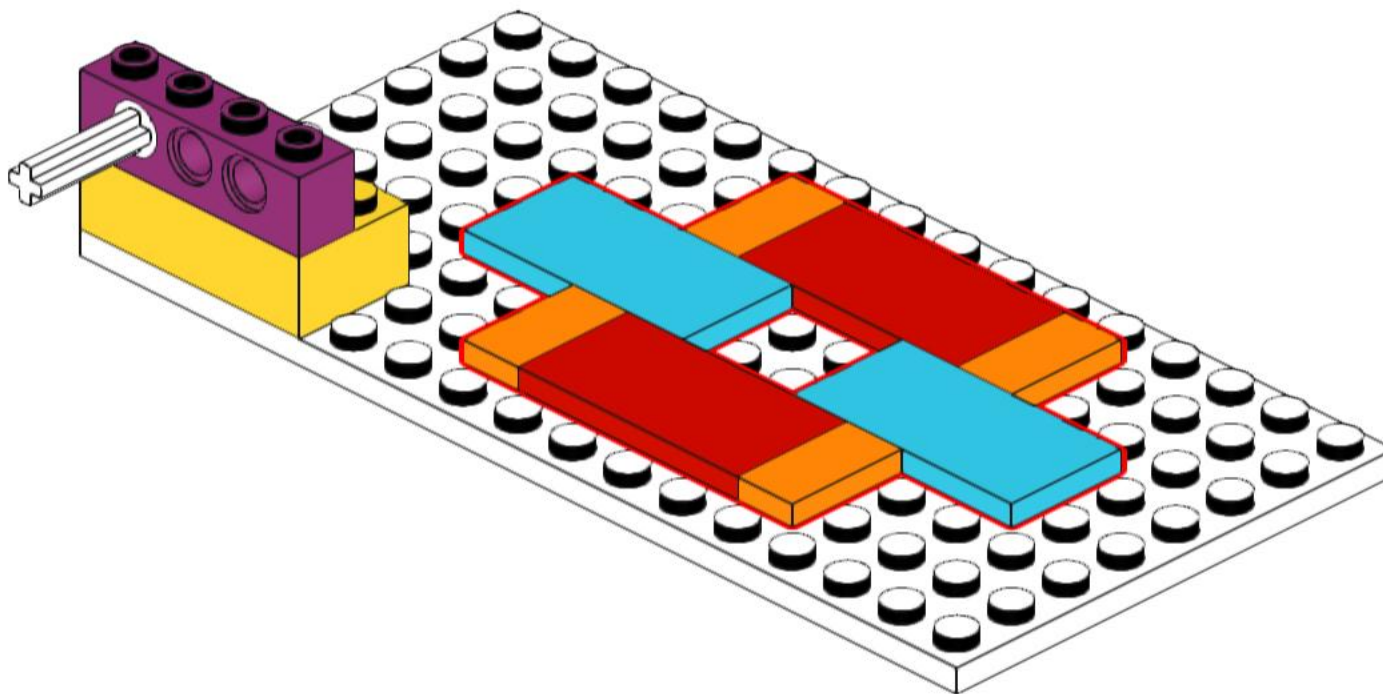
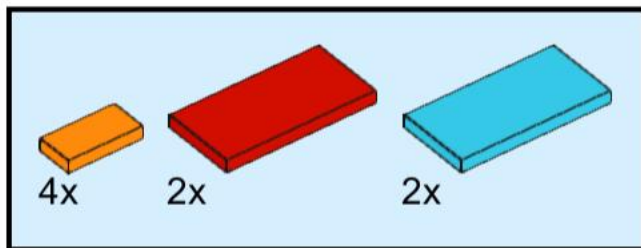

# 15

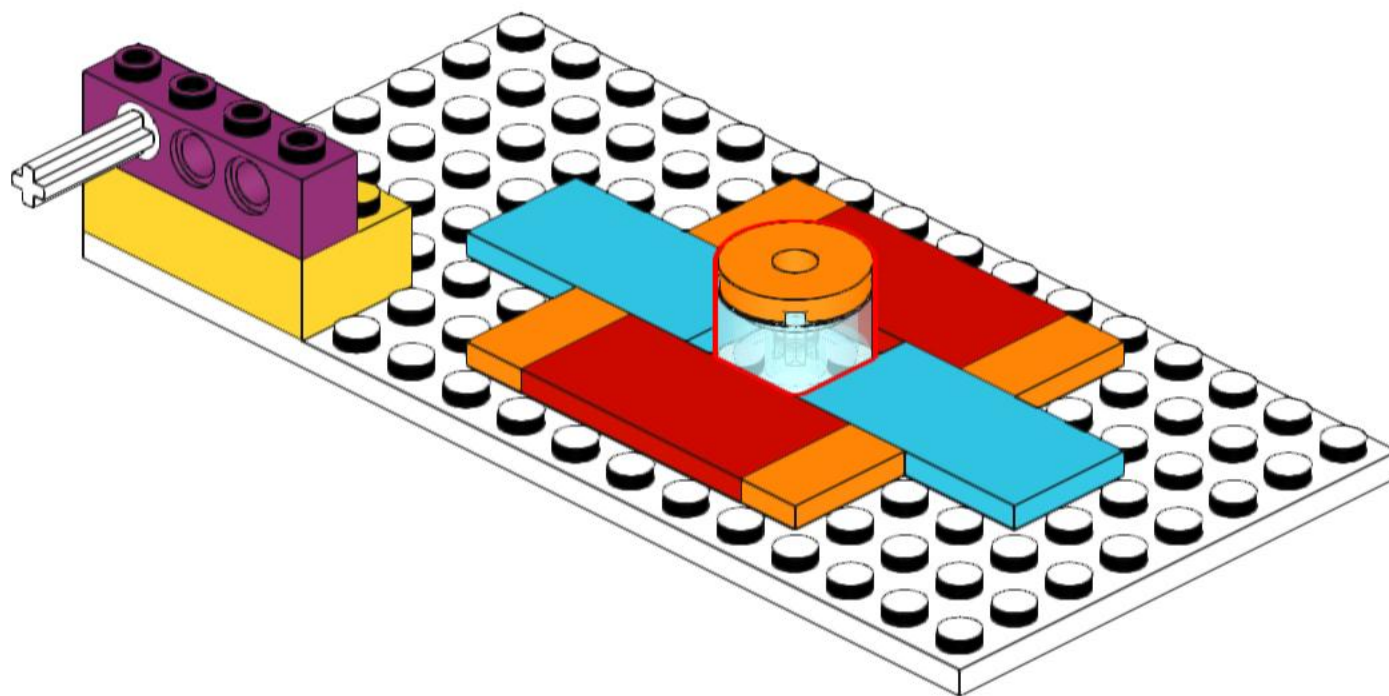
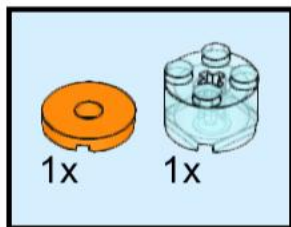



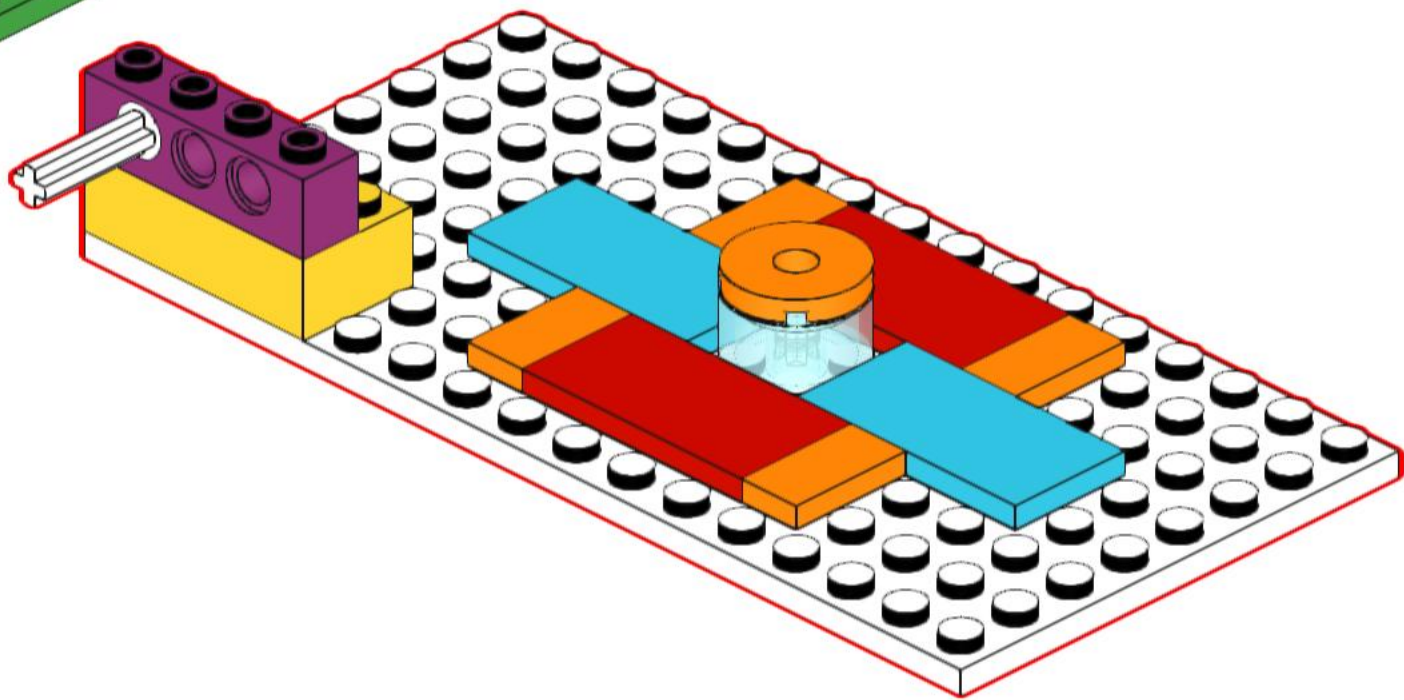
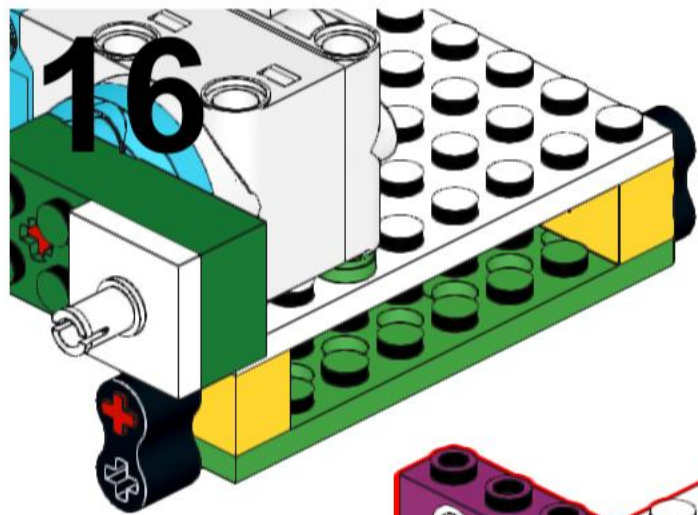

# 17

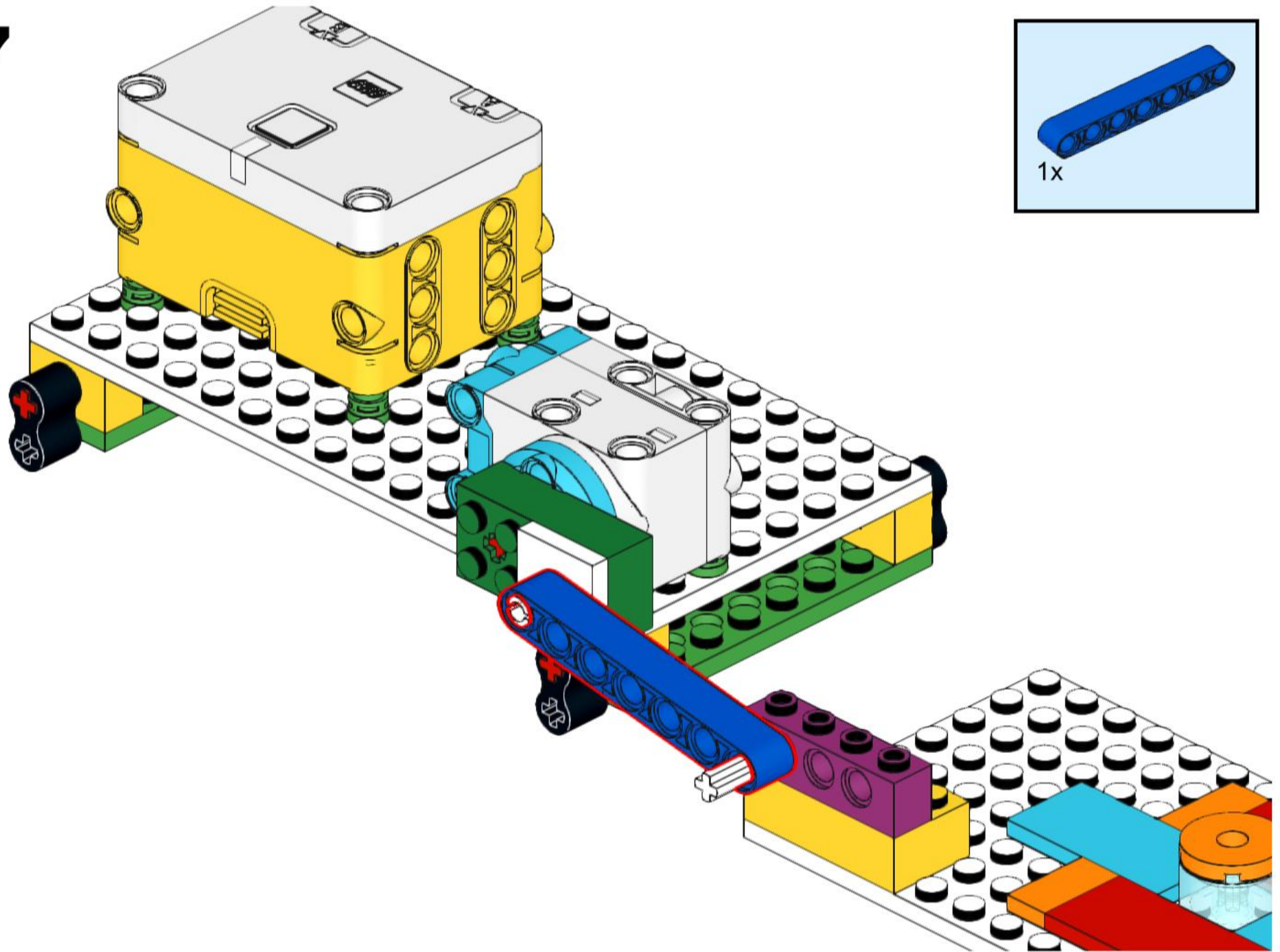

# 18

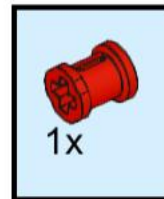
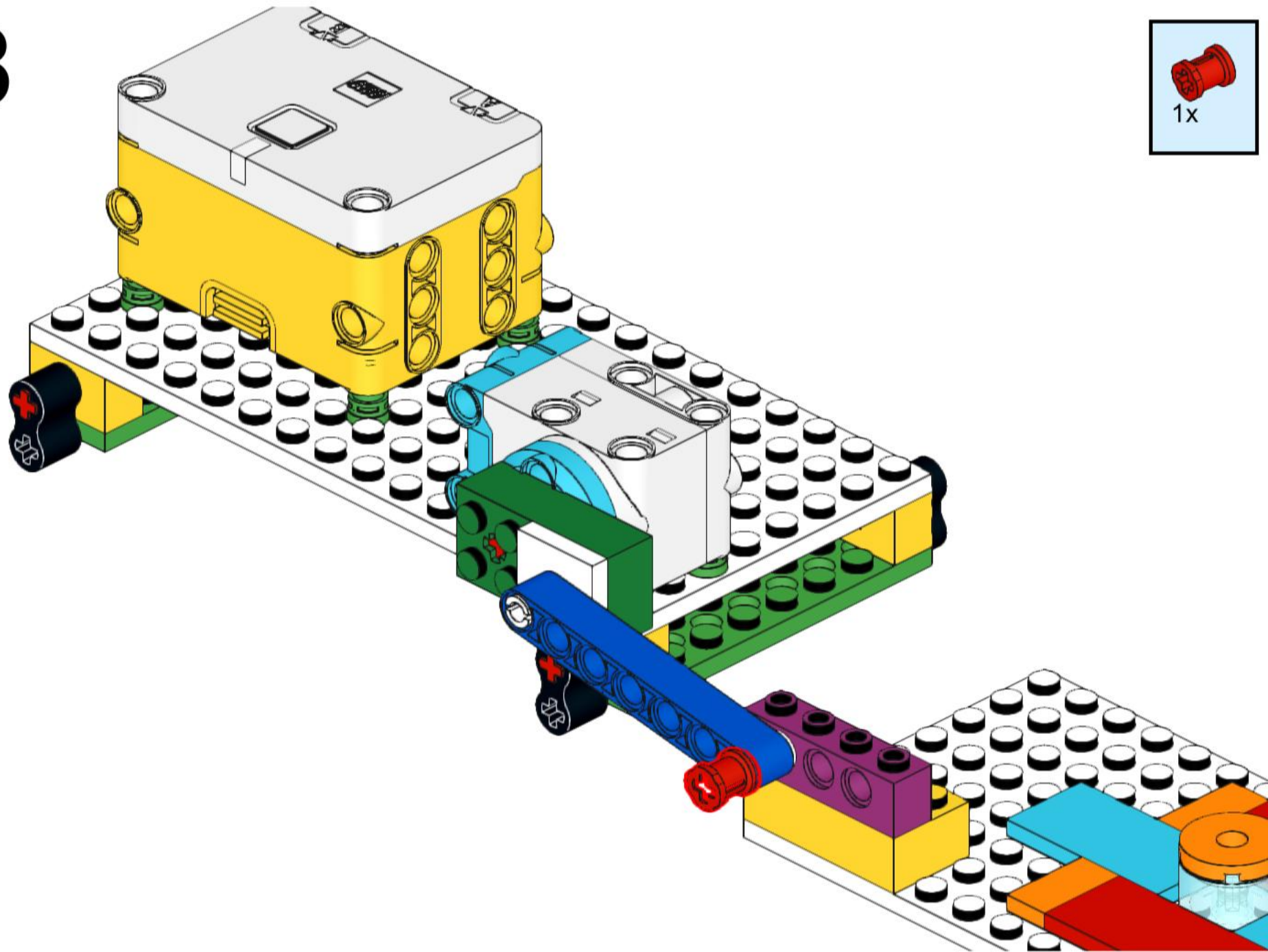

# 19

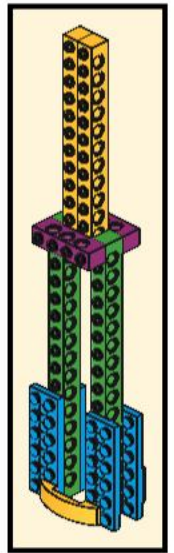
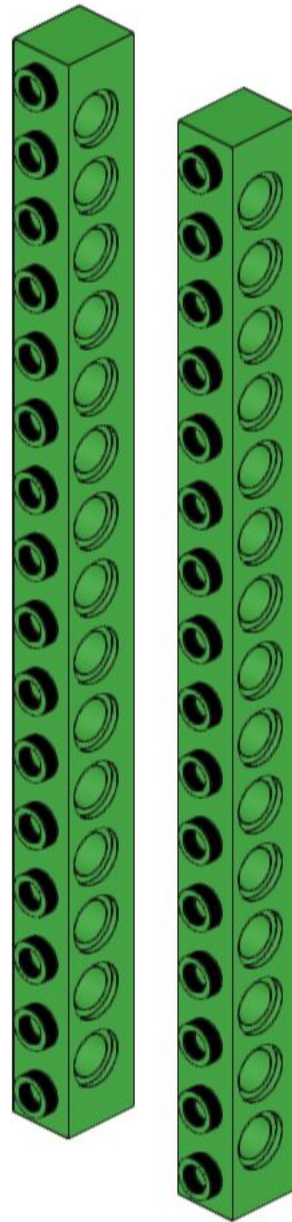
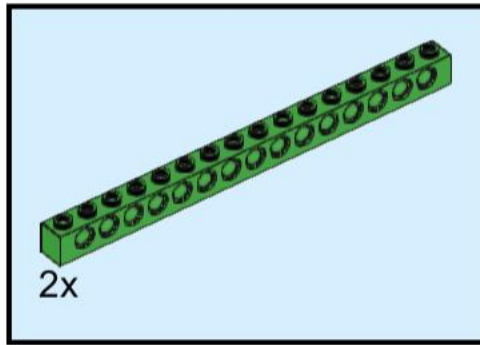



20

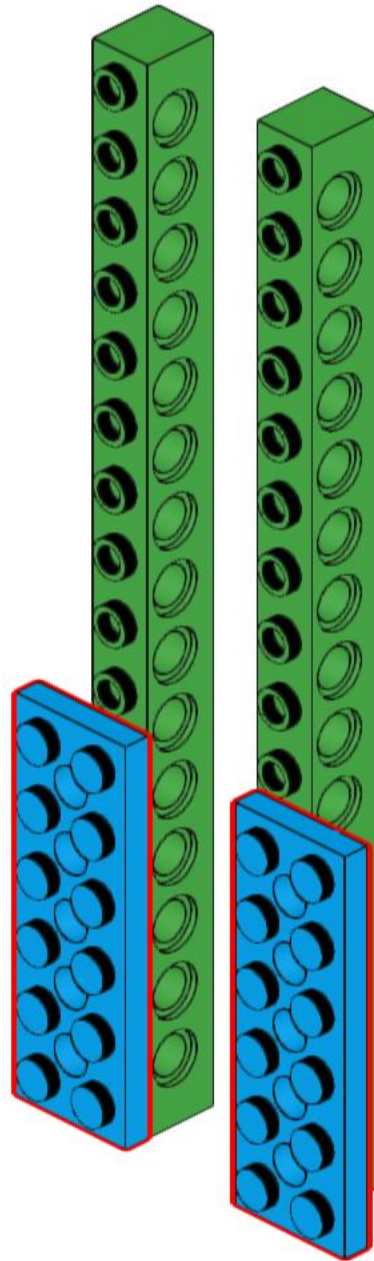
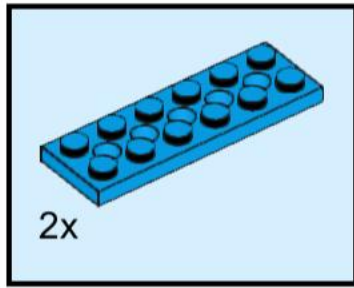

# 21

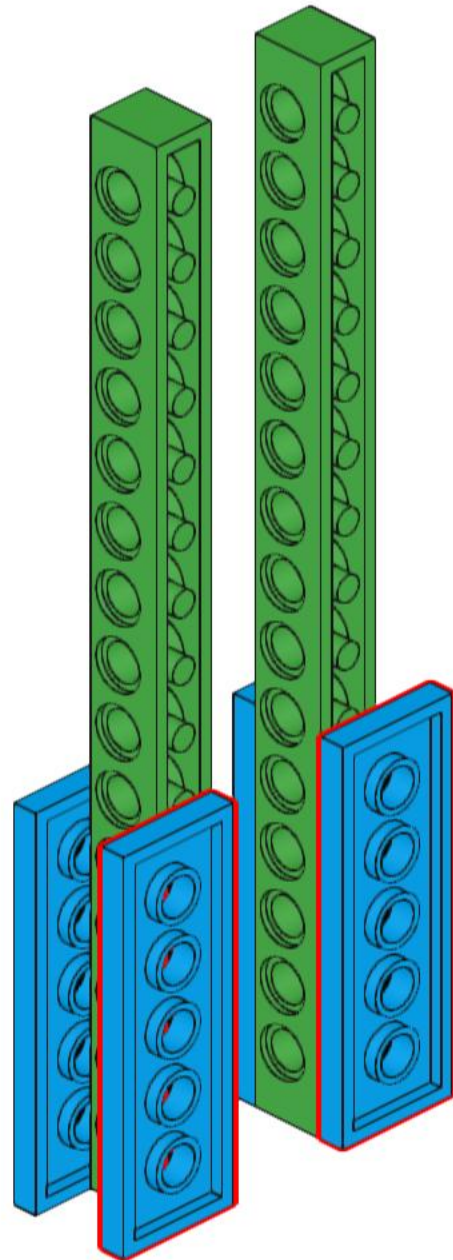
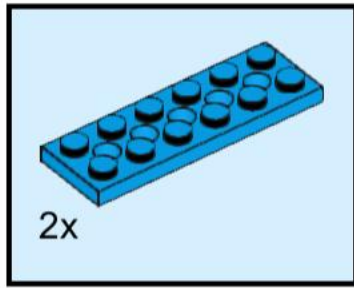

22

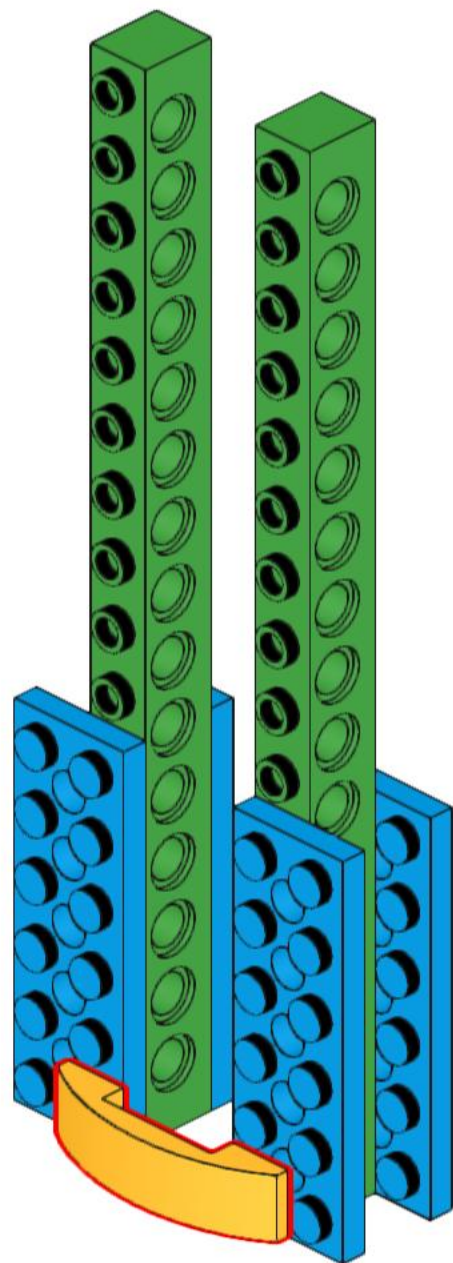
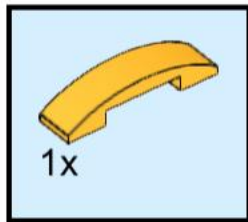



# 23

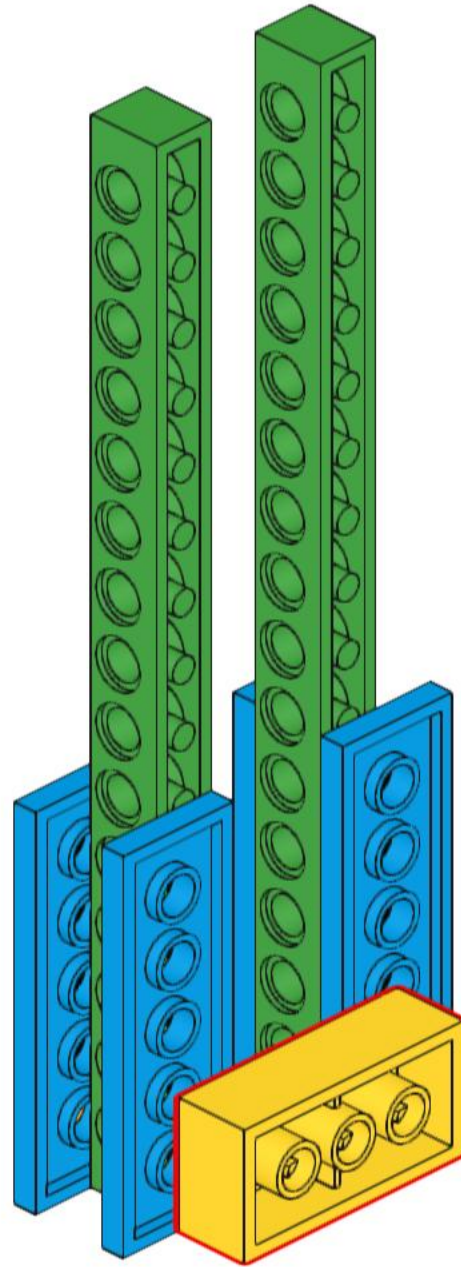
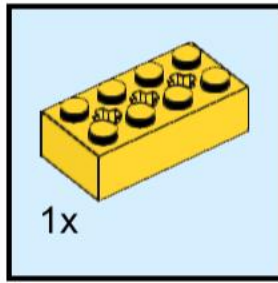

# 24

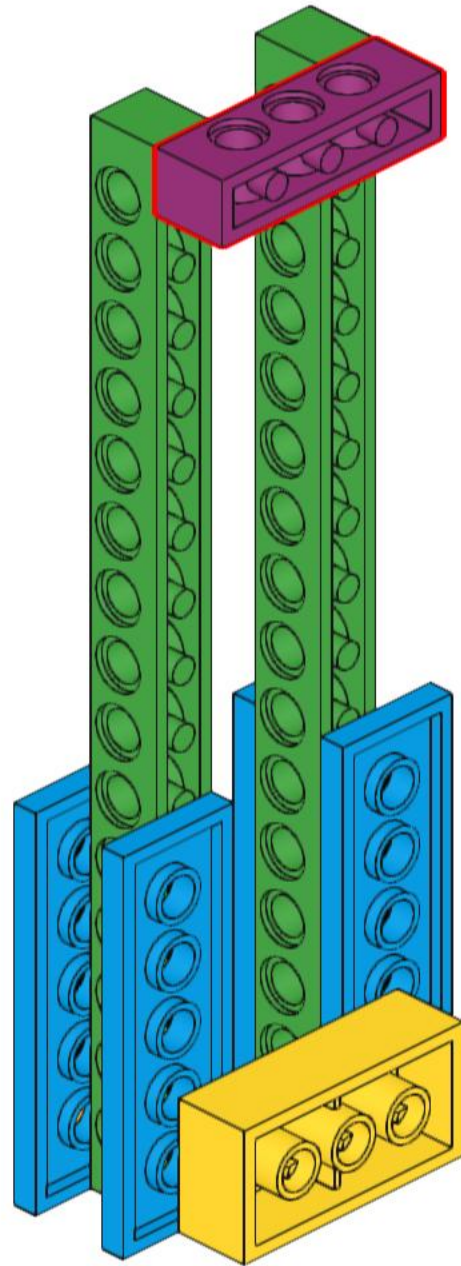
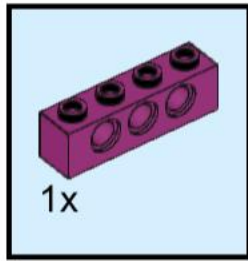

# 25

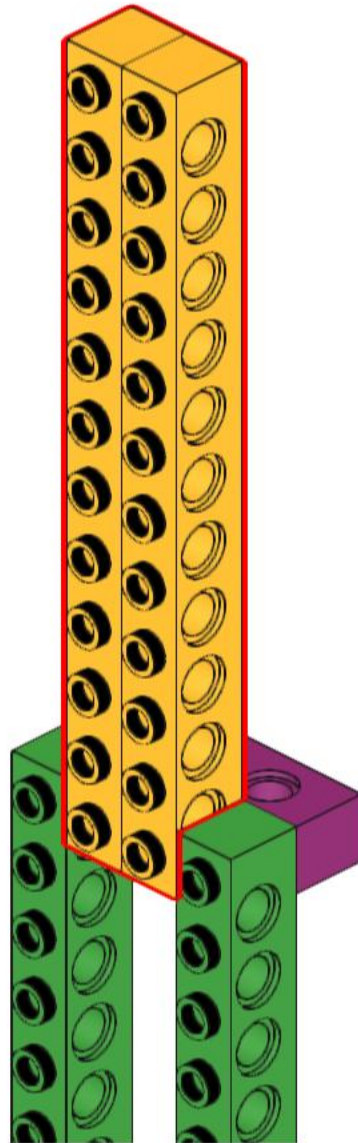
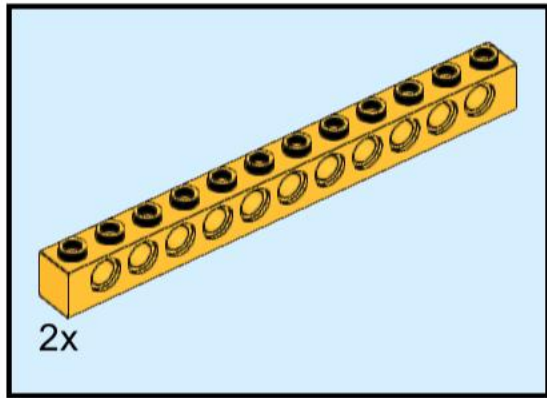

# 26

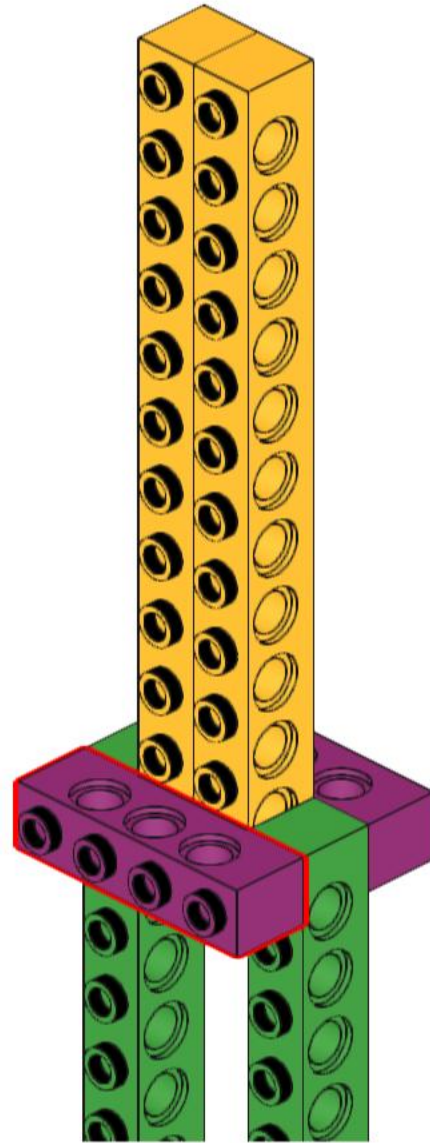
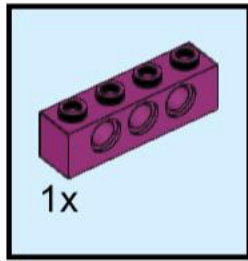

# 27

